

Renna™ Transitions Ordering Guide

Mix and match Renna™ transitions and run lengths to create one-of-a-kind designs. Use this guide to learn more about the available transitions, their sizes and nomenclature. Transitions can be combined with straight fixtures to create layers of light around your environment. Simply sketch your layout to determine the number of transitions and straight sections needed then upload your drawing to the RFA tool to get a submittal drawing and full bill of material. See below for an example.

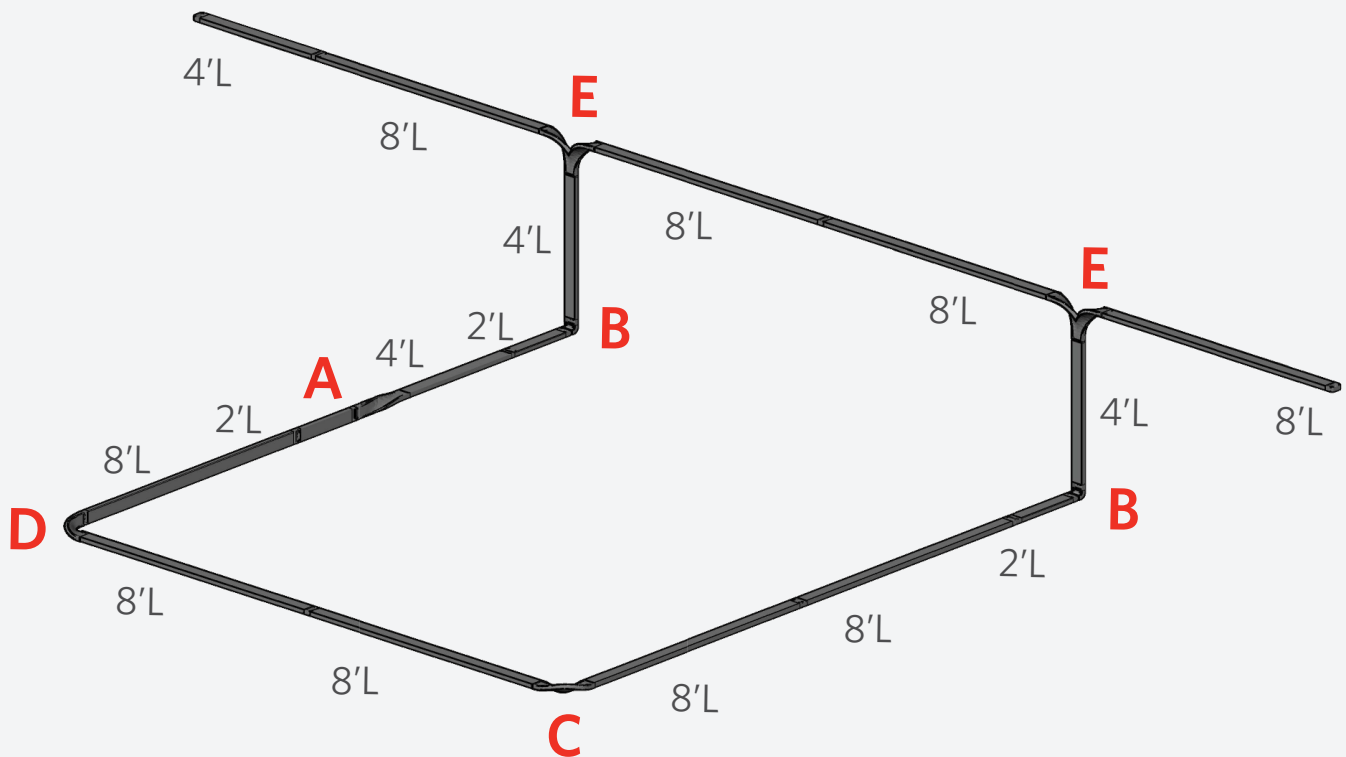

A

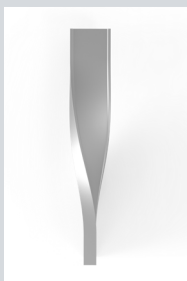

Straight Twist
180FVT24

B



Mini Curve 90
90VCC3

C



Banked Curve
90FBC12

D



Twisted Right
Curve-90FVRT12

E



Twisted Double
Curve-90FVT12

Renna™ Transitions Ordering Guide

Pendant

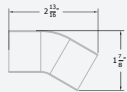

Mini Curve 30
30VC3

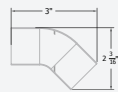

Mini Curve 45
45VC3

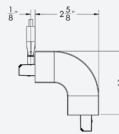

Mini Curve 90
90VCC3

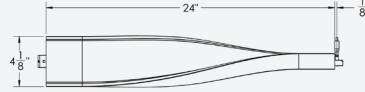

Straight Twist
180FVT24

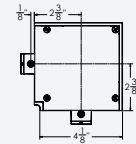

Mini Square
90FC4

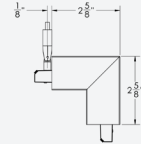

Mini Corner
90VC3

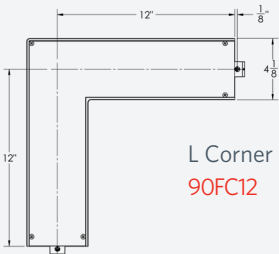

L Corner
90FC12

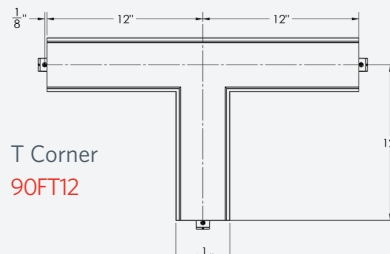

T Corner
90FT12

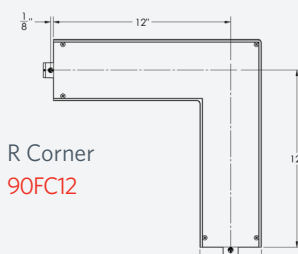

R Corner
90FC12

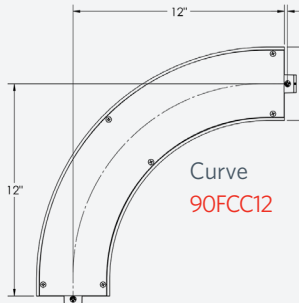

Curve
90FCC12

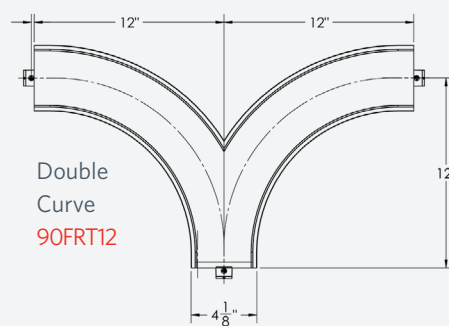

Double Curve
90FRT12

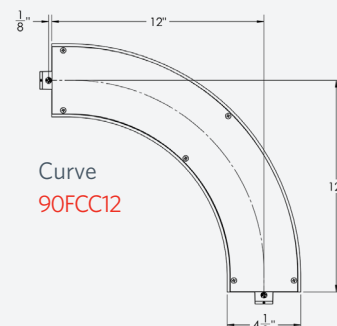

Curve
90FCC12

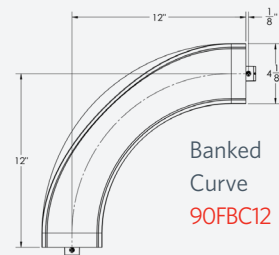

Banked Curve
90FBC12

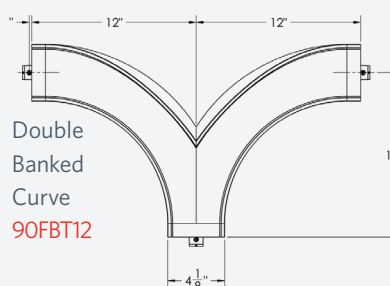

Double Banked Curve
90FBT12



Banked Curve
90FBC12

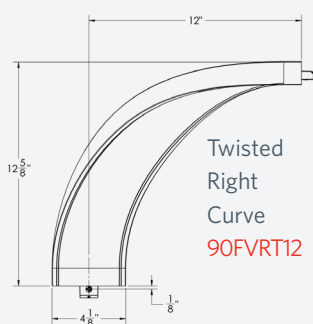

Twisted Right Curve
90FVRT12

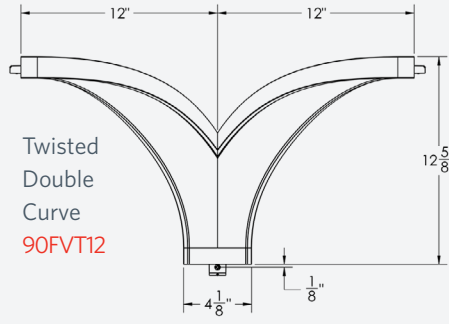

Twisted Double Curve
90FVT12

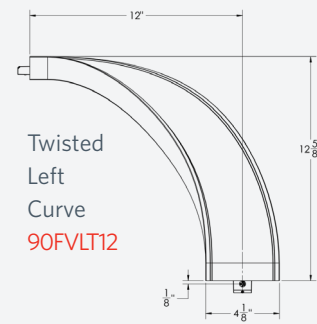

Twisted Left Curve
90FVLT12

Renna™ Transitions Ordering Guide

Surface

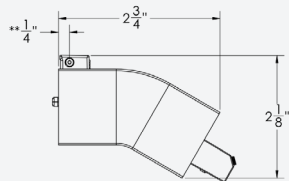

Mini Curve 30
30VC3S

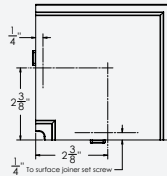

Mini Square
90FC4S

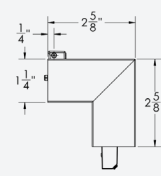

Mini Corner 90
90VC3S

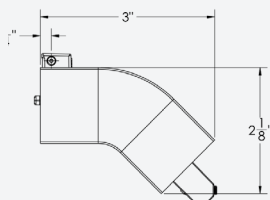

Mini Curve 45
45VC3S

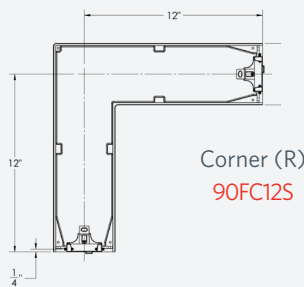

Corner (R)
90FC12S

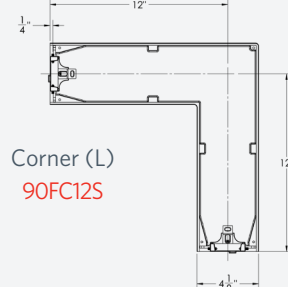

Corner (L)
90FC12S

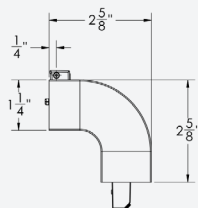

Mini Curve 90
90VCC3S

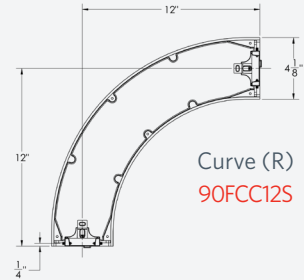

Curve (R)
90FCC12S

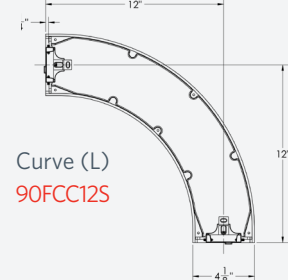

Curve (L)
90FCC12S

Specialty

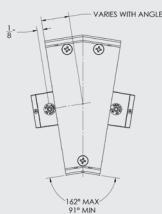

Mini Obtuse Angle
91FC4-162FC4

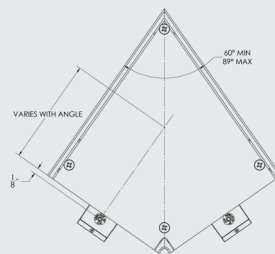

Mini Acute Angle
60FC4-89FC4

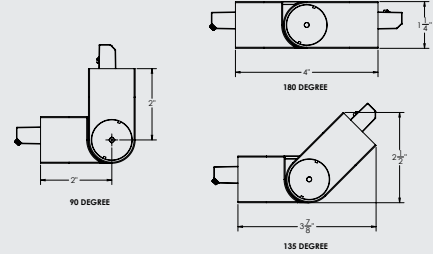

Adjustable Angle
90AA4

Wall Wash

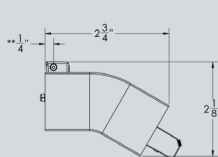

Mini Curve 30
30VWWC3

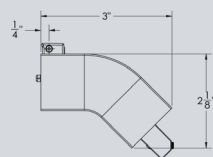

Mini Curve 45
45VWWC3

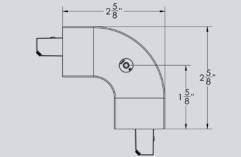

Mini Curve 90
90VWWC3

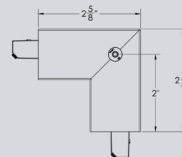

Mini Corner
90VWWCC3

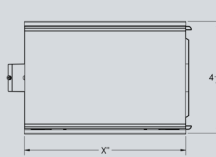

Vertical Straight
UVSTx

Peerless® Renna™ Transitions Ordering Guide

Series	Transition	Mounting Type	Overall Suspension	Finish	Options
Pendant					
RNNATR	30VC3 Mini Curve 30°	F1/ T-bar ceiling (universal mounting bracket)	24A 24" adjustable	C110 Painted Aluminum	BLK Black cord, cord manager, and canopy
	45VC3 Mini Curve 45°	F1A/ T-bar ceiling (universal mounting bracket with integrated J-box)	48A 48" adjustable	C202 Textured Black	MCS Matching Canopy at support for aesthetics
	90VCC3 Mini Curve 90°	F2/ Hard ceiling (horizontal J-box)	96A 96" adjustable	C210 Textured White	SLP Slope Ceiling
	90VC3 Mini Corner		144A 144" adjustable	CO99 Custom Color	
	90FC12 L Corner			RALTBD Ral Paint Finishes	
	90FCC12 Curve				
	90FBC12 Banked Curve				
	90FVRT12 Twisted Right Curve				
	90FVLT12 Twisted Left Curve				
	90FC4 Mini Square				
	90FT12 T Corner				
	90FRT12 Double Curve				
	90FBT12 Banked Double Curve				
	90FVT12 Twisted Double Curve				
	180FVT24 Unlit Straight Twist to Vertical 24in				
	UST3 Unlit Straight 3in				
	UST6 Unlit Straight 6in				
	UST9 Unlit Straight 9in				
	UST12 Unlit Straight 12in				
Surface					
RNNATR	30VC3S Mini Curve 30°	LF* Left		C110 Painted Aluminum	
	45VC3S Mini Curve 45°	RT* Right		C202 Textured Black	
	90VCC3S Mini Curve 90°			C210 Textured White	
	90VC3S Mini Corner	* for use with 90FC12S,		CO99 Custom Color	
	90FC12S L Corner			RALTBD Ral Paint Finishes	
	90FCC12S Curve				
	90FC4S Mini Square				
Specialty					
RNNATR	90AA4 Adjustable Angle	F1/ T-bar ceiling (universal mounting bracket)		C110 Painted Aluminum	
	XXFC4 Mini Obtuse Angle**	F1A/ T-bar ceiling (universal mounting bracket with integrated J-box)		C202 Textured Black	
	XXFC4 Mini Acute Angle***	F2/ Hard ceiling (horizontal J-box)		C210 Textured White	
				CO99 Custom Color	
				RALTBD Ral Paint Finishes	
Wall Wash					
RNNATR	30VWWC3 Mini Curve 30° VWW*	F1/ T-bar ceiling (universal mounting bracket)	24A 24" adjustable	C110 Painted Aluminum	BLK Black cord, cord manager, and canopy
	45VWWC3 Mini Curve 45° VWW*	F1A/ T-bar ceiling (universal mounting bracket with integrated J-box)	48A 48" adjustable	C202 Textured Black	MCS Matching Canopy at support for aesthetics
	90VWWC3 Mini Curve 90° VWW*	F2/ Hard ceiling (horizontal J-box)	96A 96" adjustable	C210 Textured White	SLP Slope Ceiling
	90VWWCC3 Mini Corner VWW*		144A 144" adjustable	CO99 Custom Color	
	UVST3 Unlit Vertical Straight 3in*			RALTBD Ral Paint Finishes	
	UVST6 Unlit Vertical Straight 6in*				
	UVST9 Unlit Vertical Straight 9in*				
	UVST12 Unlit Vertical Straight 12in*				
	UVST24 Unlit Vertical Straight 24in*				

Straight Fixtures: Consult individual product spec sheets for complete fixture options

Pendant Mount: RNNAD - Renna Direct (Static & TUWH) | RNNAI - Renna Indirect | RNNALD - Renna Indirect Direct

Surface Mount: RNNAS - Renna Surface Mount

Vertical Wall Wash: RNNAVWW - Renna Vertical Wall Wash Suspended Linear

** For fixed Mini Obtuse Angle **XX** will be equal to a range of 60 - 89 degrees. Example RNNATR **73FC4**

*** For fixed Mini Acute Angle **XXX** will be equal to a range of 91-162 degrees. Example RNNATR **132FC4**

When using specialty transitions please contact the factory for details and lead times